



# QUAD 2-INPUT MULTIPLEXER

The LSTTL/MSI SN54/74LS157 is a high speed Quad 2-Input Multiplexer. Four bits of data from two sources can be selected using the common Select and Enable inputs. The four buffered outputs present the selected data in the true (non-inverted) form. The LS157 can also be used to generate any four of the 16 different functions of two variables. The LS157 is fabricated with the Schottky barrier diode process for high speed and is completely compatible with all Motorola TTL families.

- Schottky Process for High Speed
- Multifunction Capability
- Non-Inverting Outputs
- Input Clamp Diodes Limit High Speed Termination Effects
- Special Circuitry Ensures Glitch Free Multiplexing
- ESD > 3500 Volts

## CONNECTION DIAGRAM DIP (TOP VIEW)

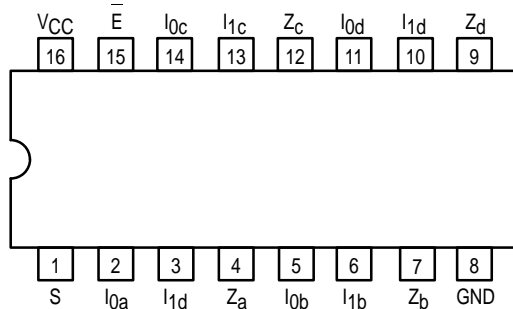

NOTE:  
The Flatpak version has the same pinouts (Connection Diagram) as the Dual In-Line Package.

## PIN NAMES

<b>S</b>	Common Select Input
<b>E</b>	Enable (Active LOW) Input
<b>I0a-I0d</b>	Data Inputs from Source 0
<b>I1a-I1d</b>	Data Inputs from Source 1
<b>Za-Zd</b>	Multiplexer Outputs (Note b)

## LOADING (Note a)

	HIGH	LOW
<b>S</b>	1.0 U.L.	0.5 U.L.
<b>E</b>	1.0 U.L.	0.5 U.L.
<b>I0a-I0d</b>	0.5 U.L.	0.25 U.L.
<b>I1a-I1d</b>	0.5 U.L.	0.25 U.L.
<b>Za-Zd</b>	10 U.L.	5 (2.5) U.L.

## NOTES:

- a) 1 TTL Unit Load (U.L.) = 40  $\mu$ A HIGH/1.6 mA LOW.  
b) The Output LOW drive factor is 2.5 U.L. for Military (54) and 5 U.L. for Commercial (74) Temperature Ranges.

## LOGIC DIAGRAM

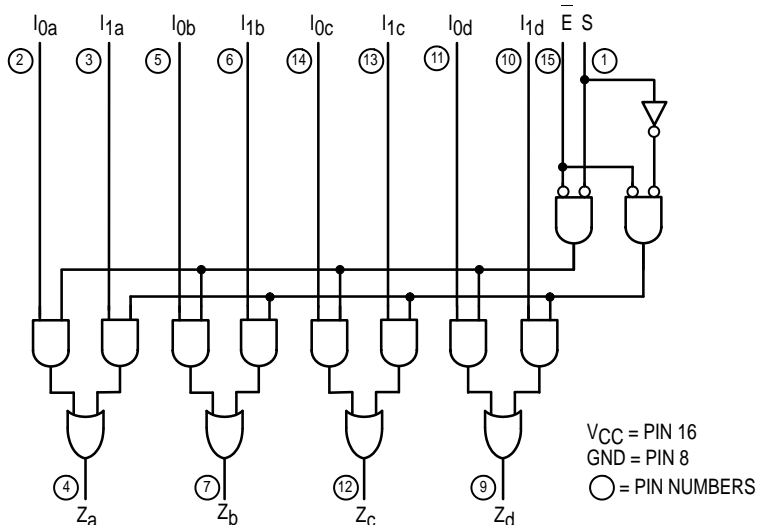

# SN54/74LS157

## QUAD 2-INPUT MULTIPLEXER LOW POWER SCHOTTKY

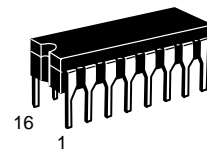

**J SUFFIX**  
CERAMIC  
CASE 620-09

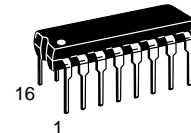

**N SUFFIX**  
PLASTIC  
CASE 648-08

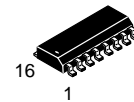

**D SUFFIX**  
SOIC  
CASE 751B-03

## ORDERING INFORMATION

SN54LSXXXJ Ceramic  
SN74LSXXXN Plastic  
SN74LSXXXD SOIC

## LOGIC SYMBOL

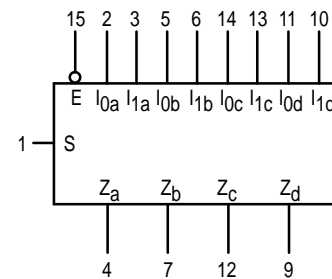

VCC = PIN 16  
GND = PIN 8

# SN54/74LS157

## FUNCTIONAL DESCRIPTION

The LS157 is a Quad 2-Input Multiplexer fabricated with the Schottky barrier diode process for high speed. It selects four bits of data from two sources under the control of a common Select Input (S). The Enable Input (E) is active LOW. When E is HIGH, all of the outputs (Z) are forced LOW regardless of all other inputs.

The LS157 is the logic implementation of a 4-pole, 2-position switch where the position of the switch is determined by the logic levels supplied to the Select Input. The logic equations for the outputs are:

$$Z_a = \bar{E} \cdot (I_{1a} \cdot S + I_{0a} \cdot \bar{S}) \quad Z_b = \bar{E} \cdot (I_{1b} \cdot S + I_{0b} \cdot \bar{S})$$

$$Z_c = \bar{E} \cdot (I_{1c} \cdot S + I_{0c} \cdot \bar{S}) \quad Z_d = \bar{E} \cdot (I_{1d} \cdot S + I_{0d} \cdot \bar{S})$$

A common use of the LS157 is the moving of data from two groups of registers to four common output busses. The particular register from which the data comes is determined by the state of the Select Input. A less obvious use is as a function generator. The LS157 can generate any four of the 16 different functions of two variables with one variable common. This is useful for implementing highly irregular logic.

TRUTH TABLE

ENABLE	SELECT INPUT	INPUTS		OUTPUT
		I <sub>0</sub>	I <sub>1</sub>	
E	S	I <sub>0</sub>	I <sub>1</sub>	Z
H	X	X	X	L
L	H	X	L	L
L	H	X	H	H
L	L	L	X	L
L	L	H	X	H

H = HIGH Voltage Level  
 L = LOW Voltage Level  
 X = Don't Care

## GUARANTEED OPERATING RANGES

Symbol	Parameter		Min	Typ	Max	Unit
V <sub>CC</sub>	Supply Voltage	54 74	4.5 4.75	5.0 5.0	5.5 5.25	V
T <sub>A</sub>	Operating Ambient Temperature Range	54 74	-55 0	25 25	125 70	°C
I <sub>OH</sub>	Output Current — High	54, 74			-0.4	mA
I <sub>OL</sub>	Output Current — Low	54 74			4.0 8.0	mA

# SN54/74LS157

## DC CHARACTERISTICS OVER OPERATING TEMPERATURE RANGE (unless otherwise specified)

Symbol	Parameter	Limits			Unit	Test Conditions	
		Min	Typ	Max			
V <sub>IH</sub>	Input HIGH Voltage	2.0			V	Guaranteed Input HIGH Voltage for All Inputs	
V <sub>IL</sub>	Input LOW Voltage	54		0.7	V	Guaranteed Input LOW Voltage for All Inputs	
		74		0.8			
V <sub>IK</sub>	Input Clamp Diode Voltage		-0.65	-1.5	V	V <sub>CC</sub> = MIN, I <sub>IN</sub> = -18 mA	
V <sub>OH</sub>	Output HIGH Voltage	54	2.5	3.5	V	V <sub>CC</sub> = MIN, I <sub>OH</sub> = MAX, V <sub>IN</sub> = V <sub>IH</sub> or V <sub>IL</sub> per Truth Table	
		74	2.7	3.5	V		
V <sub>OL</sub>	Output LOW Voltage	54, 74		0.25	0.4	V	I <sub>OL</sub> = 4.0 mA V <sub>CC</sub> = V <sub>CC</sub> MIN, V <sub>IN</sub> = V <sub>IL</sub> or V <sub>IH</sub> per Truth Table
		74		0.35	0.5	V	
I <sub>IH</sub>	Input HIGH Current I <sub>Q</sub> , I <sub>1</sub> E, S				20 40	μA	V <sub>CC</sub> = MAX, V <sub>IN</sub> = 2.7 V
	I <sub>Q</sub> , I <sub>1</sub> E, S				0.1 0.2	mA	V <sub>CC</sub> = MAX, V <sub>IN</sub> = 7.0 V
I <sub>IL</sub>	Input LOW Current I <sub>Q</sub> , I <sub>1</sub> E, S				-0.4 -0.8	mA	V <sub>CC</sub> = MAX, V <sub>IN</sub> = 0.4 V
I <sub>OS</sub>	Short Circuit Current (Note 1)	-20			-100	mA	V <sub>CC</sub> = MAX
I <sub>CC</sub>	Power Supply Current				16	mA	V <sub>CC</sub> = MAX

Note 1: Not more than one output should be shorted at a time, nor for more than 1 second.

## AC CHARACTERISTICS (T<sub>A</sub> = 25°C)

Symbol	Parameter	Limits			Unit	Test Conditions	
		Min	Typ	Max			
t <sub>PLH</sub> t <sub>PHL</sub>	Propagation Delay Data to Output		9.0 9.0	14 14	ns	Figure 2	V <sub>CC</sub> = 5.0 V C <sub>L</sub> = 15 pF
t <sub>PLH</sub> t <sub>PHL</sub>	Propagation Delay Enable to Output		13 14	20 21	ns	Figure 1	
t <sub>PLH</sub> t <sub>PHL</sub>	Propagation Delay Select to Output		15 18	23 27	ns	Figure 2	

## AC WAVEFORMS

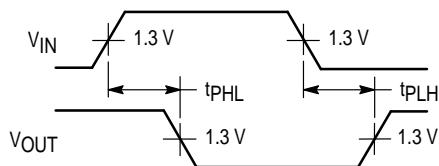

Figure 1

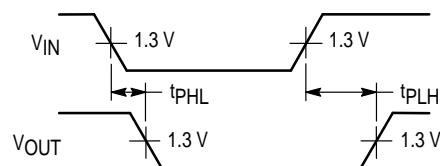

Figure 2